



US00D377096S

United States Patent [19] Michelson

[11] Patent Number: Des. 377,096
[45] Date of Patent: **Dec. 31, 1996

[54] **INTERBODY SPINAL IMPLANT**
[75] Inventor: Gary K. Michelson, Venice, Calif.
[73] Assignee: Sofamor Danek Properties, Inc.,
Memphis, Tenn.
[**] Term: 14 Years
[21] Appl. No.: 23,926
[22] Filed: Jun. 3, 1994
[52] U.S. Cl. D24/155
[58] Field of Search D24/155; 623/17;
606/61, 60, 73, 72

[56] **References Cited**

U.S. PATENT DOCUMENTS

4,501,269	2/1985	Bagby	606/61
5,015,247	5/1991	Michelson	606/61
5,246,458	9/1993	Graham	623/17
5,397,364	3/1995	Kozak et al.	623/17
5,458,638	10/1995	Kushlich et al.	623/17

Primary Examiner—Stella Reid
Attorney, Agent, or Firm—Woodard, Emhardt, Naughton
Moriarty & McNett

[57] **CLAIM**
The ornamental design for the an interbody spinal implant,
as shown and described.

DESCRIPTION
FIG. 1 is a perspective view of the an interbody threaded
spinal implant showing my new design;
FIG. 2 is a left side elevational view of the design of FIG.
1, with the right side being a mirror image thereof;
FIG. 3 is a front side elevational view of the design of FIG.
1, with the rear side being a mirror image thereof;
FIG. 4 is a cross sectional view along lines 4—4 of the
design of FIG. 3;

FIG. 5 is a cross sectional view along lines 5—5 of the
design of FIG. 3;
FIG. 6 is a top plan view of the design of FIG. 1;
FIG. 7 is a bottom plan view of the design of FIG. 1;
FIG. 8 is a perspective view of a first alternative embodi-
ment of the design of FIG. 1;
FIG. 9 is a left side elevational view of the design of FIG.
8, with the right side being a mirror image thereof;
FIG. 10 is a front side elevational view of the design of FIG.
8, with the rear side being a mirror image thereof;
FIG. 11 is a cross sectional view along lines 11—11 of the
design of FIG. 9;
FIG. 12 is a top plan view of the design of FIG. 8;
FIG. 13 is a bottom plan view of the design of FIG. 8;
FIG. 14 is a perspective view of a second alternative
embodiment of the design of FIG. 1;
FIG. 15 is a left side elevational view of the design of FIG.
14, with the right side being a mirror image thereof;
FIG. 16 is a front side elevational view of design of FIG. 14
with the rear side being a mirror image thereof;
FIG. 17 is a cross sectional view along lines 17—7 of the
design of FIG. 16;
FIG. 18 is a cross sectional view along lines 18—18 of the
design of FIG. 16;
FIG. 19 is a top plan view of the design of FIG. 14;
FIG. 20 is a bottom plan view of the design of FIG. 14;
FIG. 21 is a perspective view of a fourth alternative embodi-
ment of the design of FIG. 1;
FIG. 22 is a left side elevational view of the design of FIG.
21, with the right side being a mirror image thereof;
FIG. 23 is a top plan view of the design of FIG. 21;
FIG. 24 is a bottom plan view of the design of FIG. 21;
FIG. 25 is a front side elevational view of the design of FIG.
21 with the rear side being a mirror image thereof; and,
FIG. 26 is a cross sectional view along lines 26—26 of the
design of FIG. 25.

1 Claim, 7 Drawing Sheets

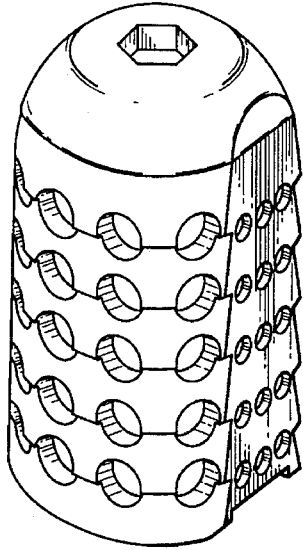

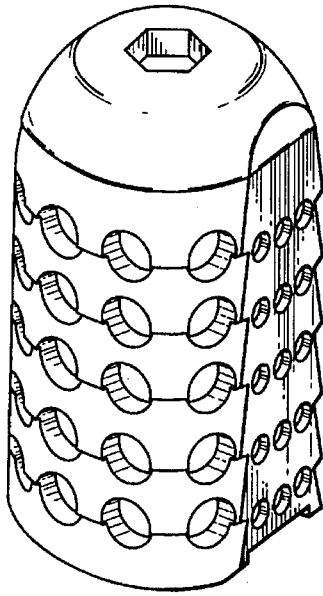

Fig. 1

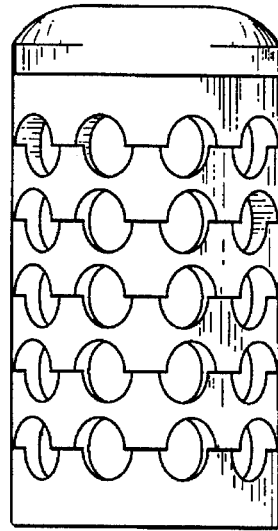

Fig. 2

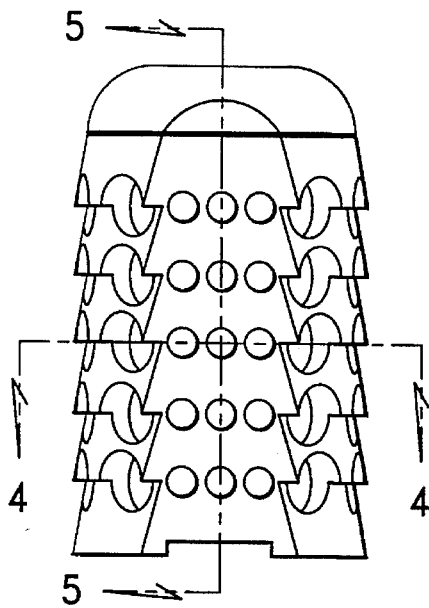

Fig. 3

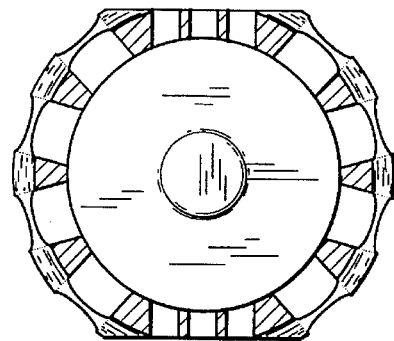

Fig. 4

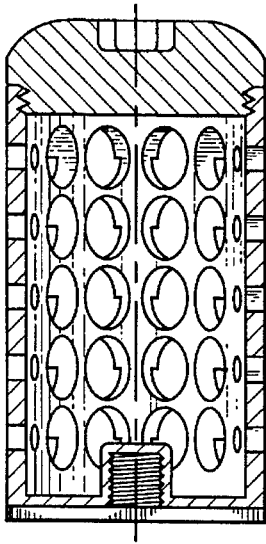

Fig. 5

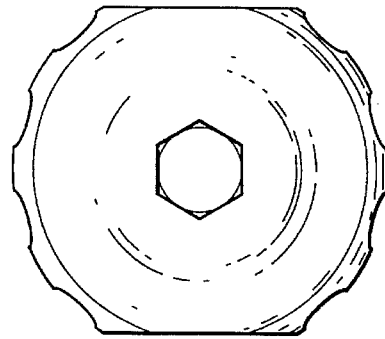

Fig. 6

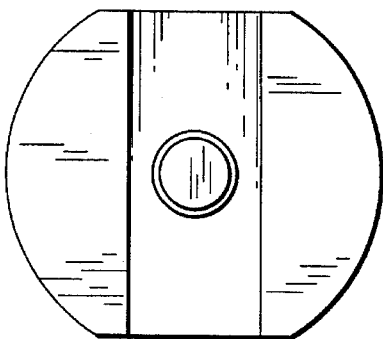

Fig. 7

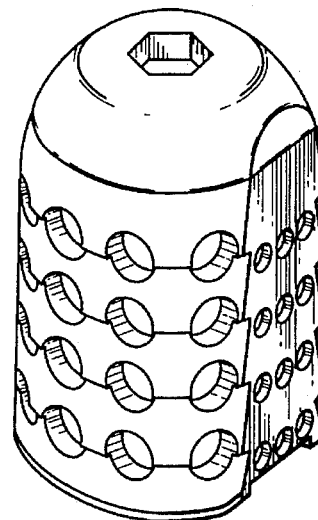

Fig. 8

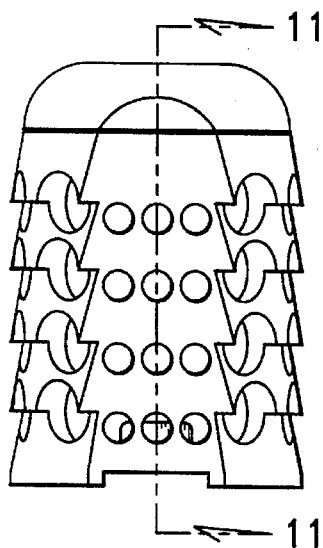

Fig. 9

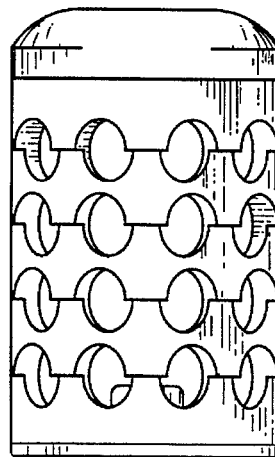

Fig. 10

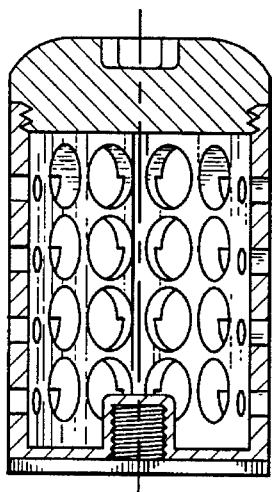

Fig. 11

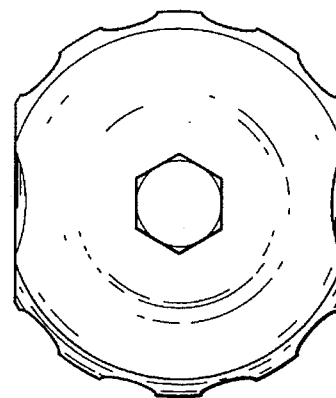

Fig. 12

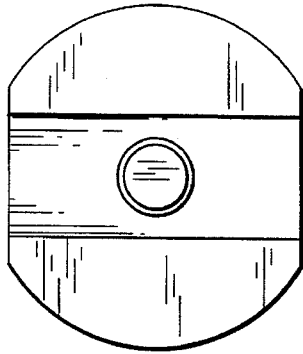

Fig. 13

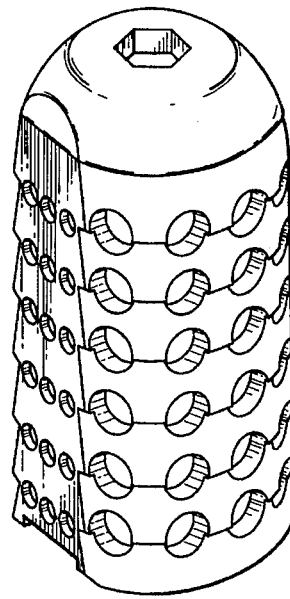

Fig. 14

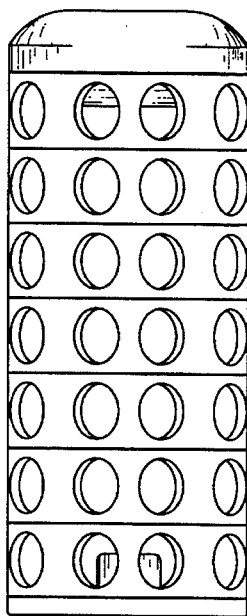

Fig. 15

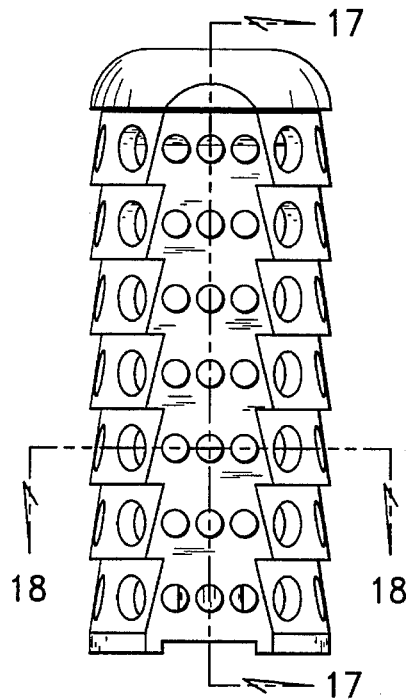

Fig. 16

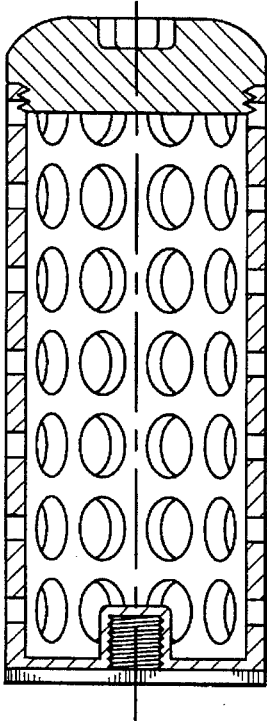

Fig. 17

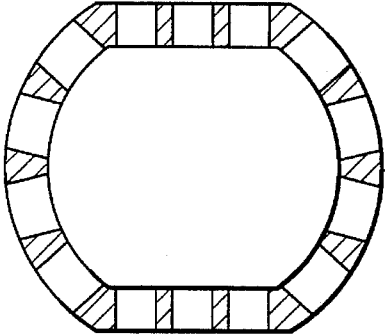

Fig. 18

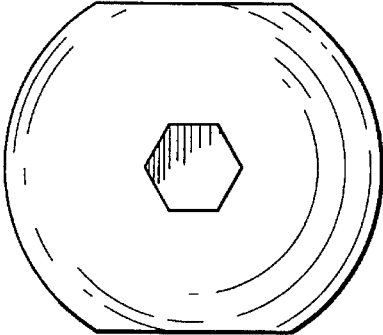

Fig. 19

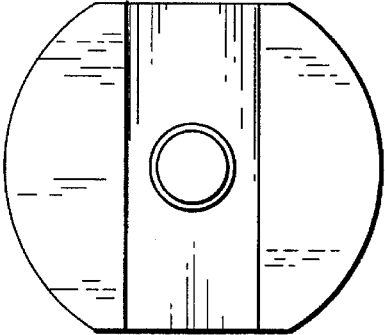

Fig. 20

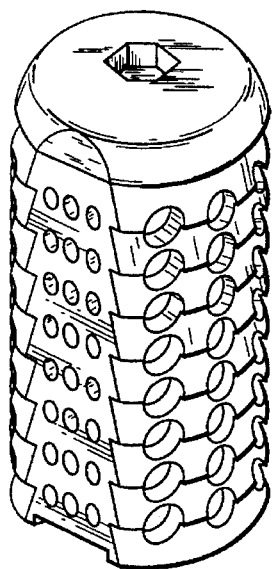

Fig. 21

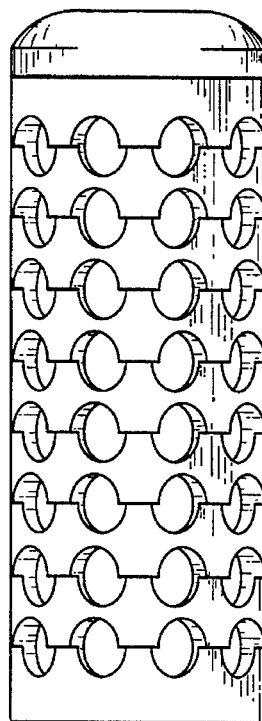

Fig. 22

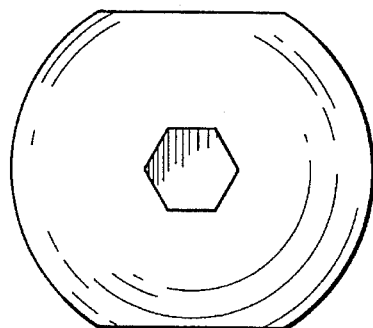

Fig. 23

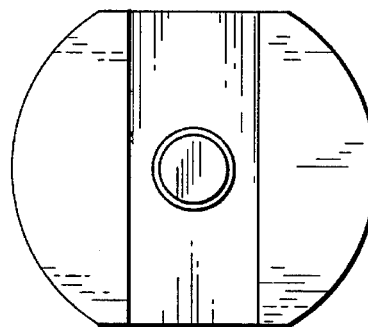

Fig. 24

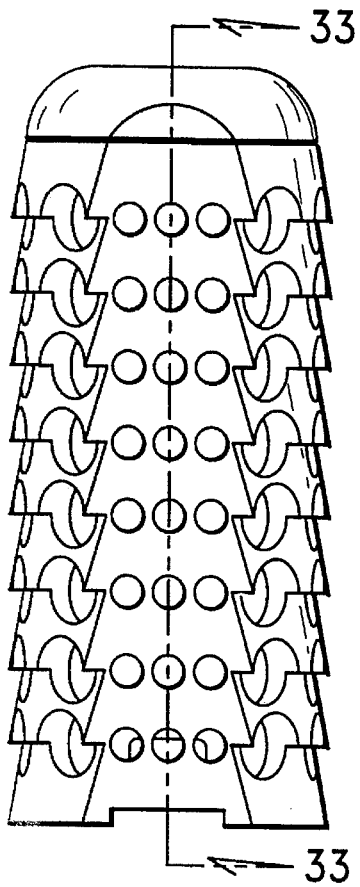

Fig. 25

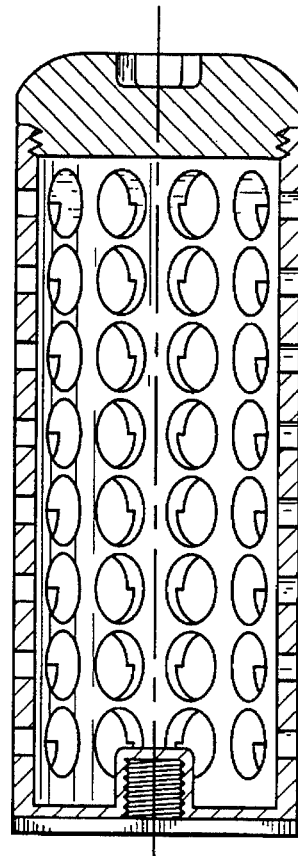

Fig. 26